

DJ Bank™

Snapshot

OK on Dimmer	⊘
Outdoor OK	⊘
Sound Activated	✓
DMX512	⊘
Master/Slave	⊘
115/220 SWITCH	⊘
Replaceable Fuse	✓
User Serviceable	⊘
Duty Cycle	⊘

USER MANUAL



TABLE OF CONTENTS

1. Before You Begin.....	2
What is included	2
Unpacking Instructions	2
Safety Instructions	3
2. Introduction.....	4
Features	4
Product Overview	4
3. SETUP	5
AC Power	5
Mounting	5
Orientation.....	5
Rigging	5
6. Appendix	6
General Maintenance	6
Returns Procedure	6
Claims	6
DJ Bank Service Maintenance Guide	7
Technical Support.....	7
Contact Us.....	7
Technical Specifications	8

1. BEFORE YOU BEGIN

What is included

- 1 x DJ Bank™
- 1 x Power cable with plug
- 1 x Warranty Card
- 1 x User Manual

Unpacking Instructions

Immediately upon receiving a fixture, carefully unpack the carton, check the contents to ensure that all parts are present, and have been received in good condition. Notify the shipper immediately and retain packing material for inspection if any parts appear damaged from shipping or the carton itself shows signs of mishandling. Save the carton and all packing materials. In the event that a fixture must be returned to the factory, it is important that the fixture be returned in the original factory box and packing.

Safety Instructions



Please read these instructions carefully, which includes important information about the installation, usage and maintenance of this product.

- Please keep this User Guide for future consultation. If you sell the unit to another user, be sure that they also receive this instruction booklet.
- Always make sure that you are connecting to the proper voltage, and that the line voltage you are connecting to is not higher than that stated on the decal or rear panel of the fixture.
- The unit must be installed in a location with adequate ventilation, at least 20in (50cm) from adjacent surfaces. Be sure that no ventilation slots are blocked.
- Always disconnect from power source before servicing or replacing lamp or fuse and be sure to replace with same lamp source.
- Secure fixture to fastening device using a safety chain. Never carry the fixture solely by its head. Use its carrying handles.
- Maximum ambient temperature (Ta) is 104°F (40°C). Do not operate fixture at temperatures higher than this.
- In the event of a serious operating problem, stop using the unit immediately. Never try to repair the unit by yourself. Repairs carried out by unskilled people can lead to damage or malfunction. Please contact the nearest authorized technical assistance center. Always use the same type spare parts.
- Never connect the device to a dimmer pack.
- Make sure the power cord is never crimped or damaged.
- Never disconnect the power cord by pulling or tugging on the cord.
- Avoid direct eye exposure to the light source while it is on.

Caution! *There are no user serviceable parts inside the unit. Do not open the housing or attempt any repairs yourself. In the unlikely event your unit may require service, please contact CHAUVET at: 954-929-1115.*

Caution! *After prolonged periods of operation, the fixture chassis may reach high temperatures. Use caution when handling this fixture.*

2. INTRODUCTION

Features

- Compact border, strip or cyc light
- Sound activated
- Fully automatic

Product Overview

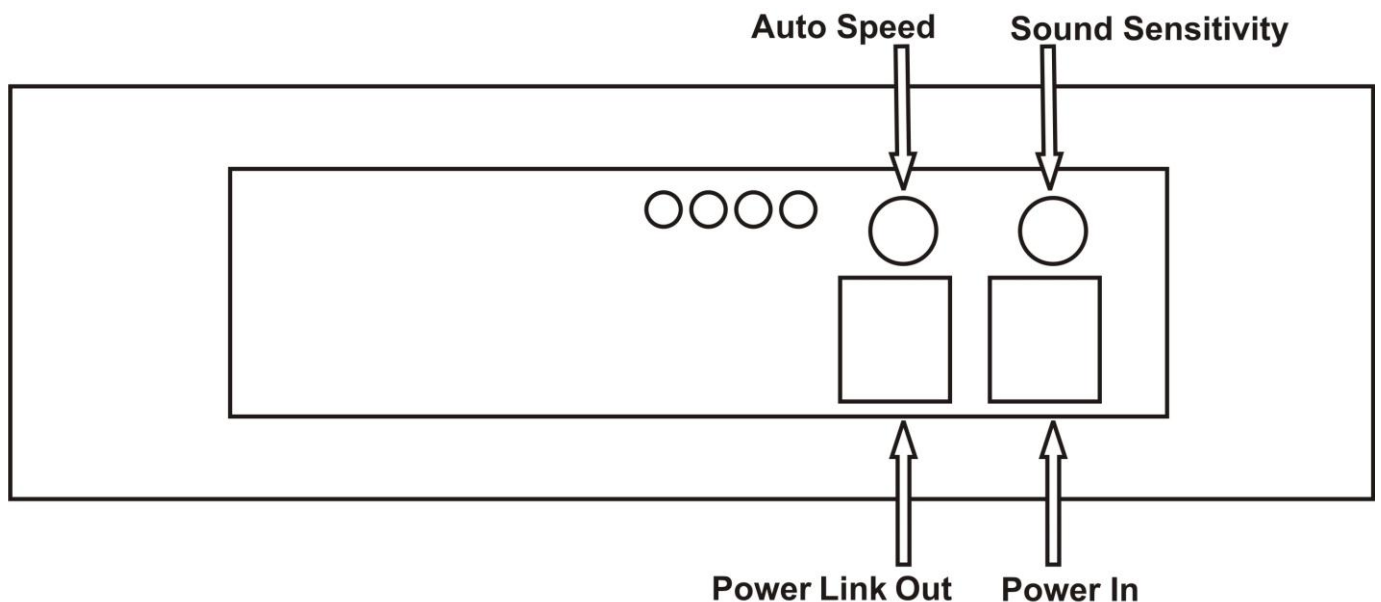

This fixture can operate in automatic mode with the speed adjustment or in sound triggering mode with the sound sensitivity adjustment.

Note: the auto speed adjustment takes priority over the sound sensitivity adjustment.

3. SETUP

AC Power

To determine the power requirements for a particular fixture, see the label affixed to the back plate of the fixture or refer to the fixture's specifications chart. All fixtures must be powered directly off a switched circuit and cannot be run off a rheostat (variable resistor) or dimmer circuit, even if the rheostat or dimmer channel is used solely for a 0% to 100% switch. Before applying power to a fixture, check that the source voltage matches the fixture's requirement.

Warning! *All fixtures must be connected to circuits with a suitable Earth Ground.*

Mounting

Orientation

This fixture may be mounted in any safe position.

Rigging

The fixture includes a mounting yoke to which a rigging clamp can be attached. You must supply your own clamp and make sure the clamp is capable of supporting the weight of this fixture. It is recommended to use at least 2 mounting points per fixture. You can order "C" and "O"-clamps from any CHAUVET dealer or distributor (CLP-15, CLP-06 recommended).

Note: There are 2 types of applications for this fixture: floor stand for up lighting, and overhead use for down lighting. If you are using this fixture for up lighting, then you must use at least 1 safety cable/chain for each fixture in addition to the mounting brackets.

If hanging the fixture for over head use, then please follow the below steps.

1. Block access below the work area and use suitable and stable platform when installing or servicing fixture.
2. Safety cables must always be used, secured through the heat sink ventilation passageway. The safety cable must be capable of holding 10 times the weight of the fixture.
3. Verify the structure can hold 10 times the weight of all to-be installed fixtures.

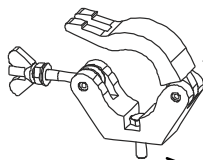

Hanging Clamp
Note: sold separately



6. APPENDIX

General Maintenance

To maintain optimum performance and minimize wear fixtures should be cleaned frequently. Usage and environment are contributing factors in determining frequency. As a general rule, fixtures should be cleaned at least twice a month. Dust build up reduces light output performance and can cause overheating. This can lead to reduced lamp life and increased mechanical wear. Be sure to power off fixture before conducting maintenance.

Unplug fixture from power. Use a vacuum or air compressor and a soft brush to remove dust collected on external vents and internal components. Clean all glass when the fixture is cold with a mild solution of glass cleaner or Isopropyl Alcohol and a soft lint free cotton cloth or lens tissue. Apply solution to the cloth or tissue and drag dirt and grime to the outside of the lens. Gently polish optical surfaces until they are free of haze and lint.

The cleaning of internal and external optical lenses and/or mirrors must be carried out periodically to optimize light output. Cleaning frequency depends on the environment in which the fixture operates: damp, smoky or particularly dirty surrounding can cause greater accumulation of dirt on the unit's optics. Clean with soft cloth using normal glass cleaning fluid. - Always dry the parts carefully. - Clean the external optics at least every 20 days. Clean the internal optics at least every 30/60 days.

Returns Procedure

Returned merchandise must be sent prepaid and in the original packing, call tags will not be issued. Package must be clearly labeled with a Return Merchandise Authorization Number (RA #). Products returned without an RMA # will be refused. Call CHAUVET and request RA # prior to shipping the fixture. Be prepared to provide the model number, serial number and a brief description of the cause for the return. Be sure to properly pack fixture, any shipping damage resulting from inadequate packaging is the customer's responsibility. CHAUVET reserves the right to use its own discretion to repair or replace product(s). As a suggestion, proper UPS packing or double-boxing is always a safe method to use.





Note: If you are given an RMA #, please include the following information on a piece of paper inside the box:

- 1) Your name
- 2) Your address
- 3) Your phone number
- 4) The RMA #
- 5) A brief description of the symptoms

Claims

Damage incurred in shipping is the responsibility of the shipper; therefore the damage must be reported to the carrier upon receipt of merchandise. It is the customer's responsibility to notify and submit claims with the shipper in the event that a fixture is damaged due to shipping. Any other claim for items such as missing component/part, damage not related to shipping, and concealed damage, must be made within seven (7) days of receiving merchandise.

DJ Bank Service Maintenance Guide

Symptom(s)	Possible Solution(s)
1 or more LED's are not illuminating	Clean the fixture regularly to avoid any such failure. This fixture is convection cooled, which means that if the surface is kept clean and free of debris, then proper cooling will be allowed to occur
	An LED may have failed, resulting in an open circuit. In this event, all of the red, green, or blue in a single module may no longer illuminate. This does not mean that all of the LEDs have failed, but the circuit may be wired in series.
	An LED may have failed, resulting in a short circuit. In this event, only the single LED which has failed will no longer function.
	<i>-Note: In the event of LED failure, a replacement LED PCB assembly may be purchased directly from Chauvet Part#: P222-DJBANK</i>
Breaker/Fuse keeps blowing	Check total load placed on the electrical circuit
	Check for a short in the electrical wiring: internal and/or external
Device has no power	Check device's fuse (internal)
	Check for power on Mains

If you still have a problem after trying the above solutions, please contact CHAUVET Technical Support at the location below.

Technical Support

Address: Service Dept.
 3000 N 29th Ct, Hollywood, FL 33020 (U.S.A.)
 Support (Email): tech@chauvetlighting.com
 Telephone: (954) 929-1115 - (Press 4)
 Fax: (954) 929-5560 - (Attention: Service)
 Website: <http://www.chauvetlighting.com>

Contact Us

World Wide

General Information Chauvet Lighting
 3000 North 29th Court
 Hollywood, FL 33020
 voice: 954.929.1115
 fax: 954.929.5560
 toll free: 800.762.1084)

World Wide Web www.chauvetlighting.com

Technical Specifications

WEIGHT & DIMENSIONS

Length 15.8 in (401 mm)
Width 4.5 in (114 mm)
Height 5.5 in (140 mm)
Weight 2.7 lbs (1.2 kg)

POWER

AC Power 115VAC 60Hz or 230VAC 50Hz
Power Consumption..... 6W (0.89A) max @ 120V 60Hz

LIGHT SOURCE

Quantity 140 (35 Red, 35 Blue, 35 Green, 35 Yellow)

PHOTOOPTICS

Beam angle..... 12°
Field angle..... 24°
Luminance @ 1M..... 47 lux

COOLING..... CONVECTION COOLED

STANDARD ORDERING INFORMATION

DJ Bank TM DJBANK

SPARE PARTS ORDERING INFORMATION

Master PCB (Part)..... P170-DJBANK
LED PCB (Part)..... P222-DJBANK
Bracket kit (Part) P111-DJBANK
Front plastic lens (Part) P114-BANKDJ

WARRANTY INFORMATION

Warranty..... 1-year limited warranty